

Metal Earth. LEGENDS

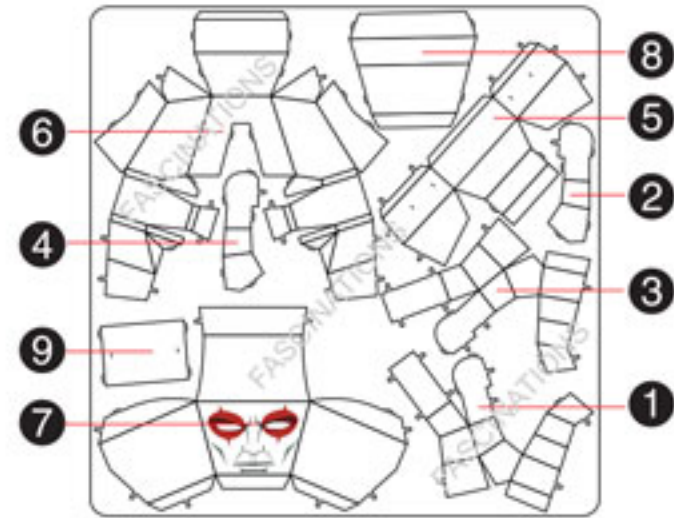

DRAX



Tweezers or needle nose pliers are helpful for assembly.

To create the best connections

- Insert tab and bend 90 degrees for most visible areas
- ▲ Insert tab and twist 90 degrees is best in some areas to ensure a tight connection

Fold lines can be seen as shown here

Insertion holes

Insertion tabs are inserted and then folded or twisted



It is recommended that you visit www.metalearth.com/help/mem009 for more information when assembling this model.

! In order to avoid possible injury from sharp edges, please carefully discard the metal sheet after parts have been removed

Assembly Flow Chart

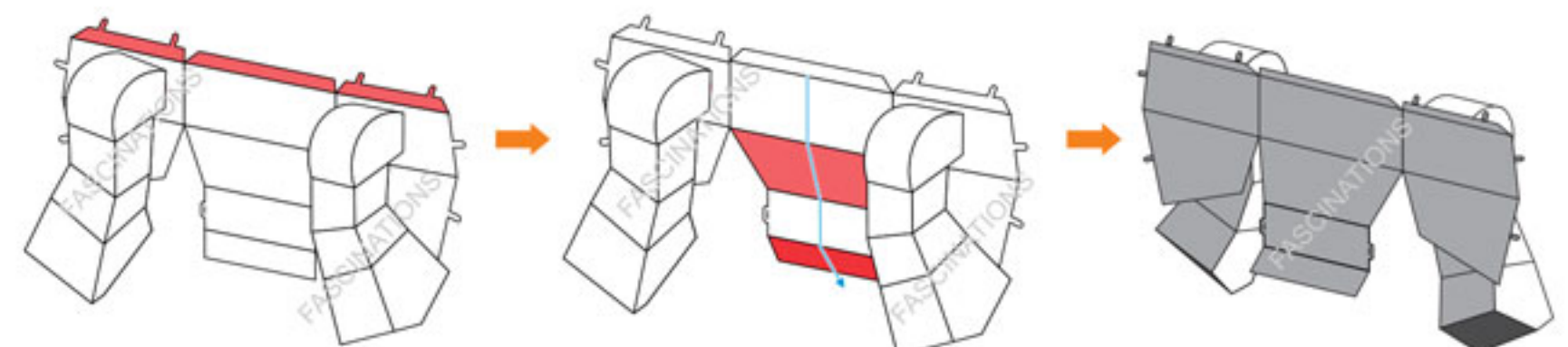
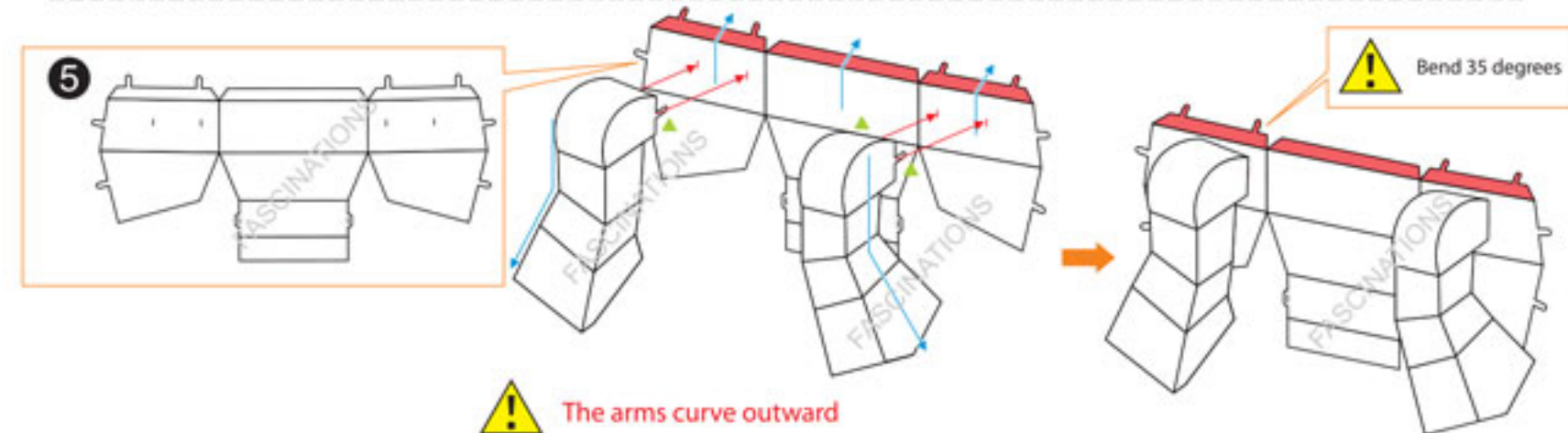
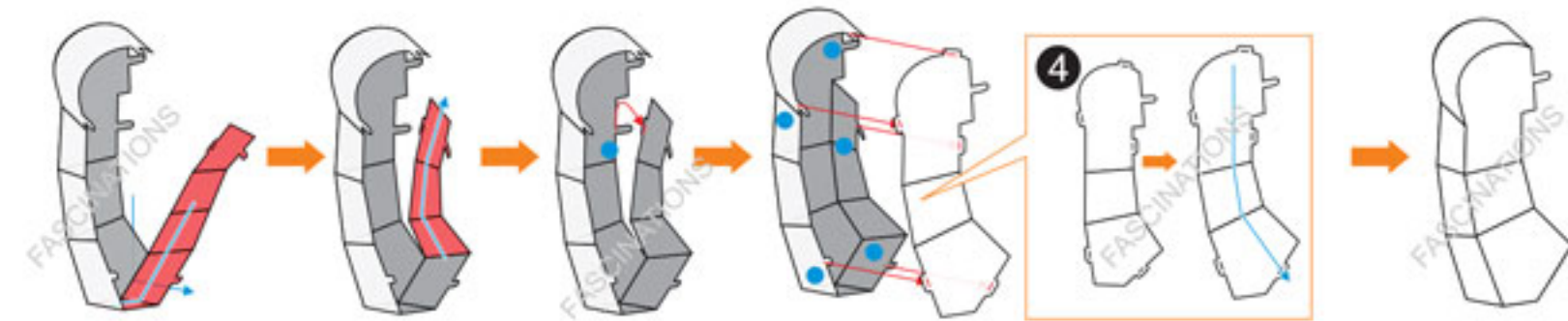
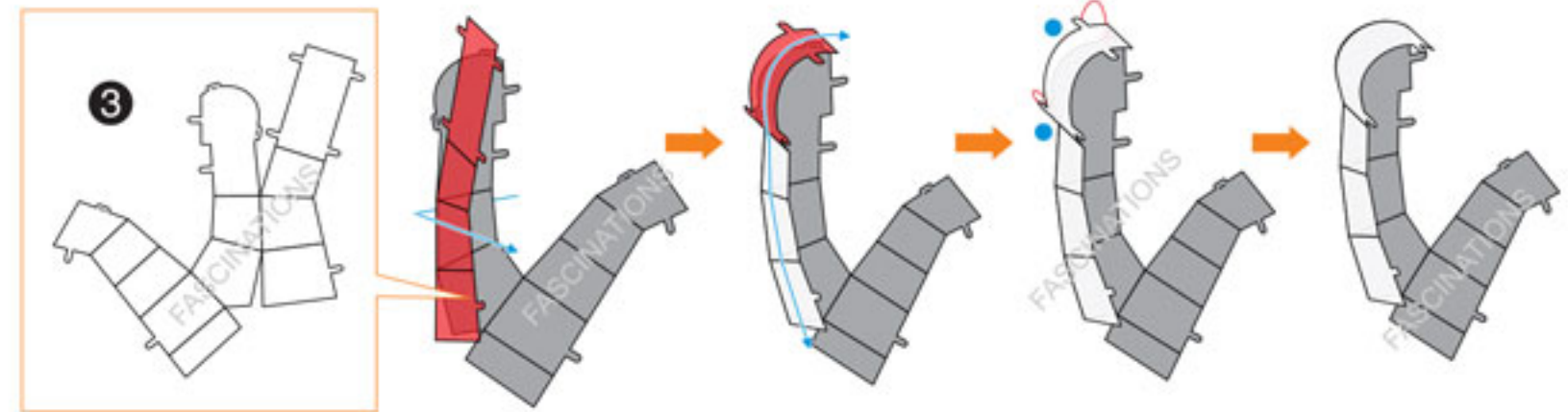
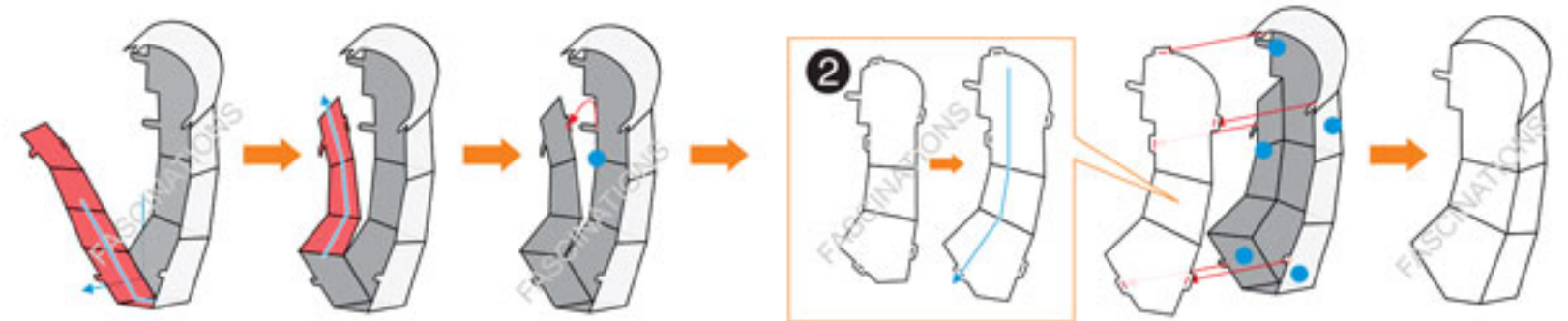
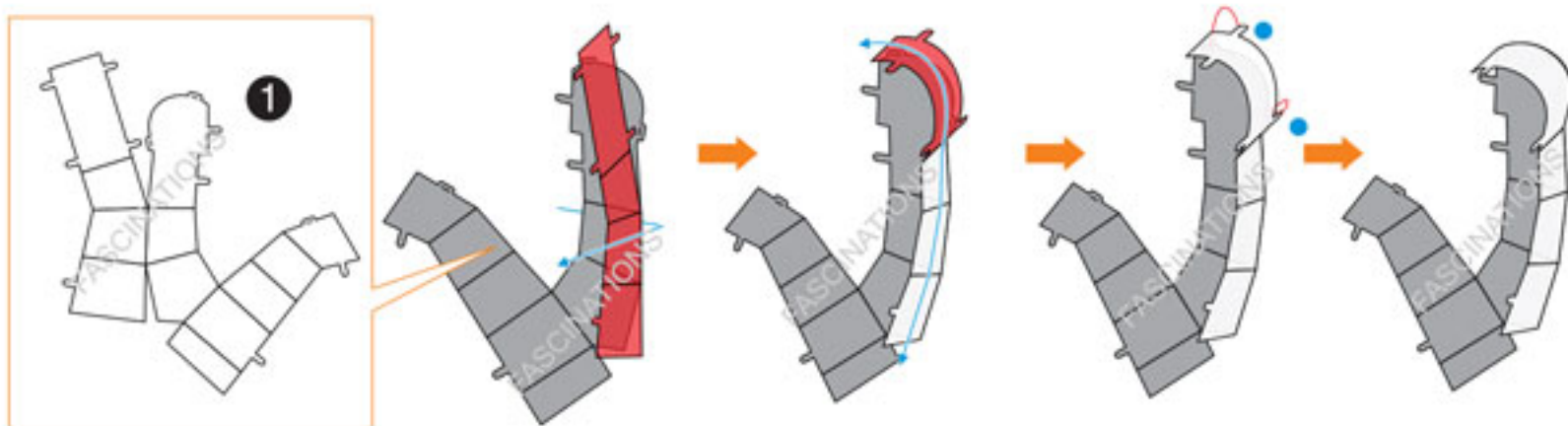

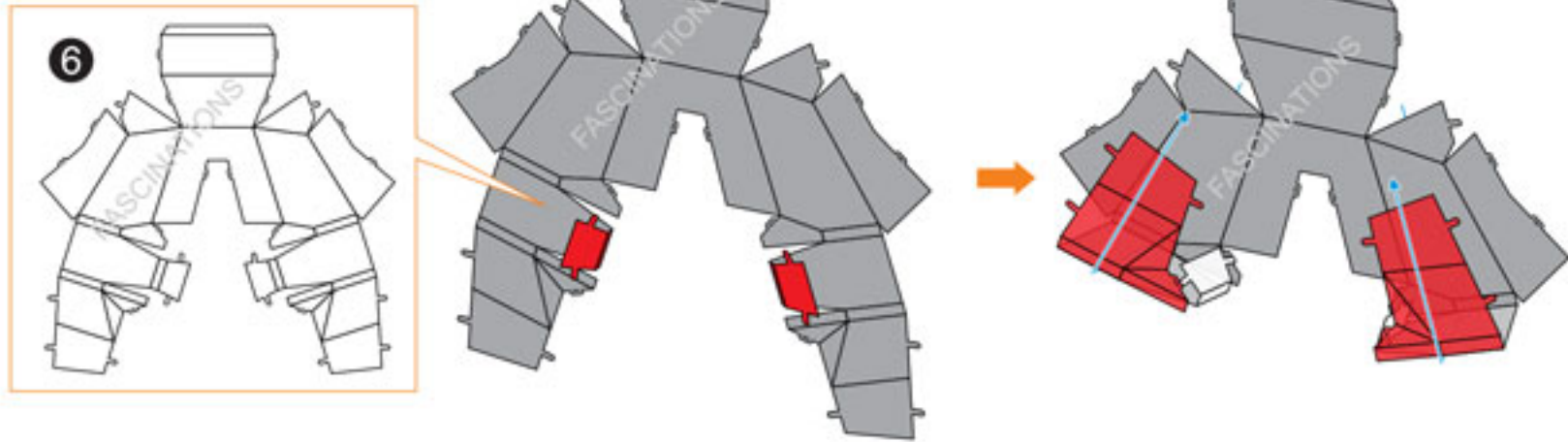

Note: This is perspective from the other side.

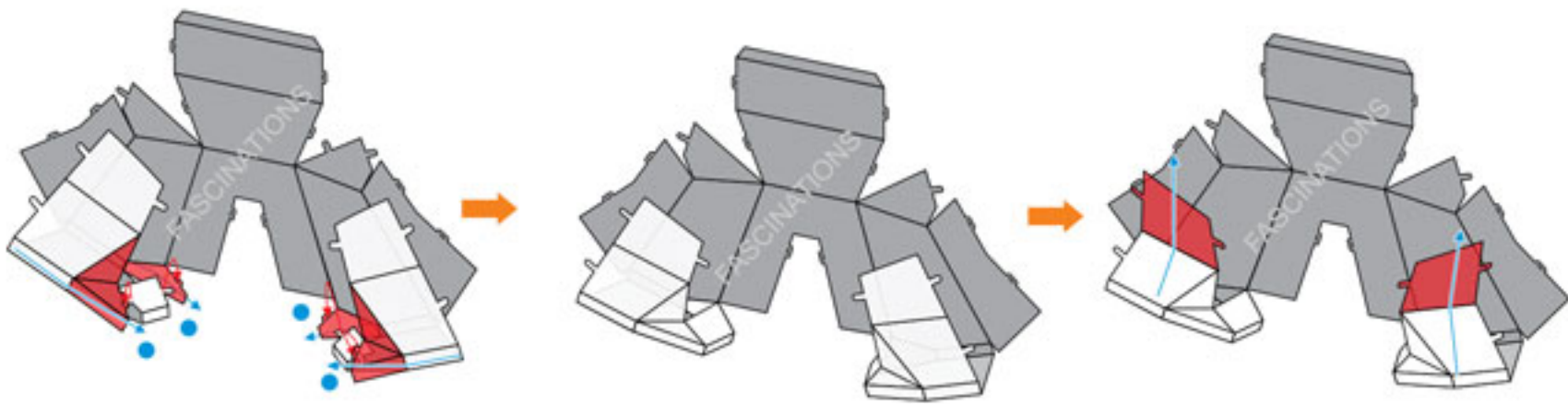

Note: This is perspective from the other side.

